

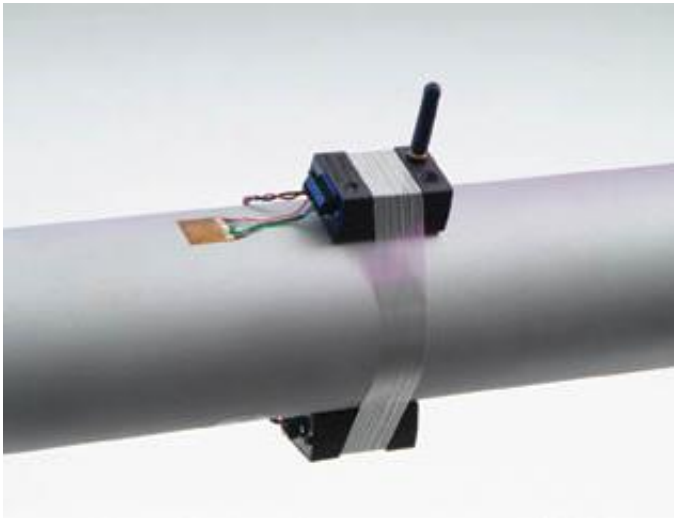

TorqueTrak 10K Torque Telemetry System



User's Guide

Table of Contents

System Overview	2
System Components	3
Features and Controls	4
RX10K Receiver	4
Figure 1: Front view of the RX10K	4
Figure 2: Rear panel of the RX10K	5
TX10K-S Transmitter	10
Figure 3: TX10K-S Transmitter	10
RM10K Remote Control	12
Figure 4: RM10K Remote Control	13
Product Safety	16
Installation Procedure	16
Field Testing	17
Bench Testing	20
Calibration	21
Warranty and Service Information	22
FCC Rules Part 15: Computing Devices	23
Appendix A: TorqueTrak 10K Specifications	24
Appendix B: Calibration Calculations	29
B1: Torque on Round Shafts	30
B2: Axial Strain on Round Shafts	35
B3: Single Grid (1/4 Bridge)	37
Appendix C: Error Codes	38
Appendix D: Strain Gage Application	39

This document is subject to change without prior notification.

System Overview

The TorqueTrak 10K Torque Telemetry System utilizes proven digital RF technology to transmit a single data signal (most typically from a strain gage) a distance of 20 feet (6 meters) or more depending on the environment. Up to 16 systems can operate simultaneously on independent channels.

The system, comprised of three main components, was designed with many user-friendly features.

RX10K Receiver

- Stable 500Hz frequency response
- Selectable gain, offset, polarity and channel settings
- Digital data (RS-232) and analog voltage output signals
- Multiple level, selectable low pass output filtering
- Seven unique simulated transmitter inputs
- Simple keypad and LCD display for easy user interface

TX10K-S Transmitter

- High signal-to-noise ratio for excellent resolution
- Low temperature coefficient for accuracy from -25 to 85°C
- Wide power supply input range from 7 to 18VDC
- Power Standby mode to extend battery life
- Two on-board shunt calibration values
- Status Indicator light to assist in troubleshooting
- Reinforced housing fits securely on any size shaft
- Circuit fully encapsulated and shielded from EMI/RFI

RM10K Remote Control (for TX10K-S Transmitter)

- Change Transmitter setup without tools or removal from shaft
- Infrared signal transmits up to 20 feet (6 meters)
- Handheld with a simple keypad

The TorqueTrak 10K is a robust, precision strain measurement instrument ideal for short-term data collection and diagnostic testing. It is designed to withstand harsh field conditions with ease-of-use in mind.

System Components

A standard TorqueTrak 10K Torque Telemetry System includes the following items:

- TX10K-S Transmitter
- Transmitter Antenna
- RX10K Receiver
- Receiver Antenna Element
- Receiver Antenna Magnetic Base with 25ft Cable
- RM10K Remote Control
- BH10K Battery Holder
- 110VAC-12VDC or 220VAC-12VDC Wall Plug Transformer
- 5-ft DB9 Cable
- 5-ft 2-Conductor Power Cable
- 10-ft 4-Conductor Ribbon Cable
- BS900 Bridge Simulator
- Screwdriver
- 3/32" Hex Wrench
- BH10K Cover Screws with vibration-resistant coating (2)
- 9V Battery Connector
- 9V Lithium Batteries (2)
- 1 Roll of 1" Fiberglass Reinforced Strapping Tape
- Butyl Rubber Sheet
- TT10K User's Guide
- TT10K Equipment Case

Features and Controls

RX10K Receiver

The RX10K Receiver features a simple keypad on the front panel for user configuration and adjustment. A two-line display indicates the operational status of the RX10K. The RX10K outputs the signal received from the TX10K-S Transmitter in three ways: 1) as text and graphics on the display, 2) as an analog voltage signal, and 3) as a digital data signal.

The top line of the RX10K display indicates the average level of the transmitted signal in numerical form on the left and in graphical form on the right (Figure 1). The numeric value corresponds to the Voltage Output signal in millivolts. For example, an output signal of +8.450V would be displayed as “+08450”. The bar graph provides a visual representation of the output signal level. Each position on the bar graph represents approximately 2V. Both the numerical and graphical indicators are averages of the received signal level over a time period of about 0.2 seconds.

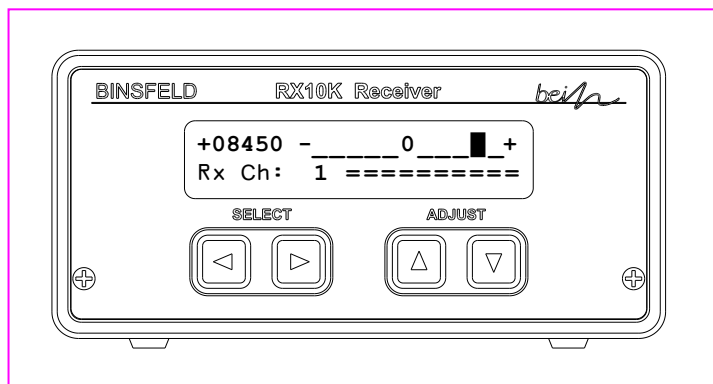

Figure 1: Front view of the RX10K

When an operational error is detected, the top line of the display alternates between the corresponding error code and the actual signal. See Appendix C for a complete list of error codes.

Located on the RX10K rear panel is the On/Off Power switch, a jack for 12VDC Power Input, a Fuse housing, a connector for attaching the Receiver Antenna, binding posts for the analog Voltage Output, and a Com (DB9) connector for the digital data signal. The analog Voltage Output signal has a nominal range of $\pm 10\text{VDC}$ and a maximum range of $\pm 12\text{VDC}$. The digital data signal is an RS-232 type signal for input to a PC "Com" port. See Appendix A for the pin out and protocol.

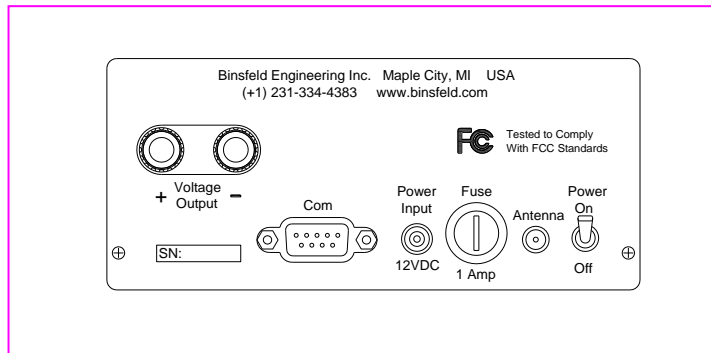

Figure 2: Rear panel of the RX10K

CAUTION: The Power Input, Voltage Output and Com (digital output) share a common (or ground) connection. Specifically, the outside ring of the Power Input, the "-" jack of the Voltage Output and pin 5 of the Com output are all internally connected.

Care must be taken in connecting the RX10K to external components in order to eliminate ground loop problems. Such ground loop currents can cause errors in the output signals and possible internal damage.

The included power supply is electrically isolated and will eliminate any ground loop problems with the Power Input. It is recommended that the Com (digital output) and Analog Output are not connected to external equipment at the same time. An exception to this rule exists when one of the two external devices accepting the analog or digital output signal is "floating" or not externally connected, such as battery operated voltmeter or a laptop powered by batteries.

User Parameter Selection and Adjustment

The RX10K Receiver has seven user-configurable parameters. The parameter name and value are shown on the lower line of the display. Parameters are selected by scrolling through the parameter menu using the **SELECT** ◀▶ (left and right) arrow keys. The value of that parameter is adjusted using the **ADJUST** ▲▼ (up and down) arrow keys. The parameter name is displayed on the left side and the value on the right. A description of the parameter screens and possible settings follow.

Channel

The Channel parameter allows the user to change the receiving RF channel to match the RF channel of the TX10K-S. There are 16 RF channels. Appendix A contains a table listing the RF channels and their corresponding frequencies. Along with the channel selection value, a bar graph indicating the relative RF signal strength being received is displayed. The more “=” units, the better the signal strength (ten is maximum).

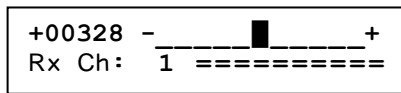

Input

The Input parameter allows the user to simulate certain inputs from the TX10K-S. These can be used to check the operation and settings of the RX10K, even without a transmitter. The possible values are listed below:

<u>Input</u>	<u>Description</u>
Transmitter	The TX10K-S signal is the input (normal operating mode)
+FS	Positive Full Scale input is simulated
Zero	Zero level signal input is simulated
-FS	Negative Full Scale input is simulated
+FS/2	Positive half scale input is simulated
-FS/2	Negative half scale input is simulated
+FS/4	Positive quarter scale input is simulated
-FS/4	Negative quarter scale input is simulated

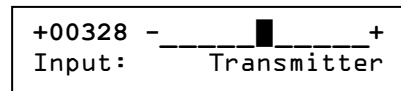

Filter

The Filter parameter allows the user to change the bandwidth of the output signal. It functions as a low pass filter, meaning frequencies above the selected value are attenuated. This allows the user to reduce the amount of high frequency data on the output signal (i.e., reduce noise) and effectively average the output value. Selectable values are 500, 250, 120, 60, 30, 15, 8, 4, 1 Hz.

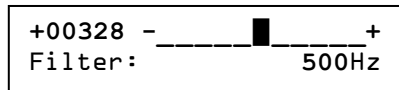

NOTE: Changing the Filter settings also changes the reception error rate detection threshold. This means that using a lower Filter setting may improve data integrity in an electrically noisy environment (where RF interference is present).

Input AutoZero

The Input AutoZero parameter provides an easy way to compensate the output for any offset from the gage or sensor. When turned On ("Input AutoZero: On"), the existing input from the TX10K-S becomes the input zero. Before adjusting the Gain, apply the AutoZero to the input signal. In this way, the zero (0V) output will not change when the Gain setting is adjusted. When the AutoZero is off ("Input AutoZero: Off"), no offset correction is applied to the output signal.

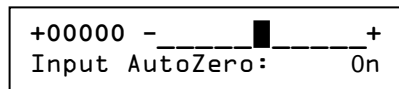

To turn the AutoZero On, press and hold the **ADJUST ▲** key for 2 seconds. To turn the AutoZero Off, press and hold the **ADJUST ▼** key for 2 seconds. In order for AutoZero to properly zero the output, the displayed output number must be stable. Switching the Filter to a lower frequency setting may help stabilize the signal to enable an effective AutoZero. The Filter may then be returned to its original setting for normal operation. The AutoZero function will not work properly if there are 1) too many "Tx→Rx Data" errors, 2) the signal from the TX10K-S is over or under range, or 3) the Input parameter is not set to "Transmitter".

Polarity

The Polarity parameter allows the user to change the polarity of the output signal.

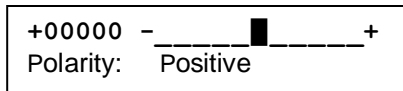

Gain

The Gain parameter allows the user to adjust the gain or scale factor applied to the input signal and is reflected in the display output, the Voltage Output signal, and the digital (RS-232) output signal. The Transmitter Gain is displayed on the left ("Gain T:02000 S:02000") and is changed using the RM10K Remote Control. The System Gain is shown on the right ("Gain T:02000 S:02000") and is the parameter adjusted on the RX10K.

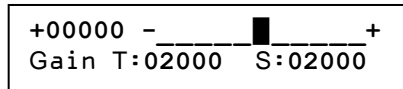

The Transmitter Gain is set based on the microstrain (µε) range expected during a given test (see table below; strain values assume a Gage Factor of 2.0).

Transmitter Gain Setting	Full Scale Strain (Full Bridge, µε)
500	±4000
1000	±2000
2000	±1000
4000	±500
8000	±250
16000	±125

Full Scale Strain corresponds to a display reading of 10000, an analog Voltage Output value of 10 VDC, and a digital data output of 10000. The System Gain can be adjusted from 25% to 400% of the Transmitter Gain (i.e., ¼ to 4 times the Transmitter Gain) for convenient output scaling. The equation below relates strain input to Voltage Output.

$$\text{Measured Strain } (\mu\epsilon) \times \text{Gage Factor} \times V_{\text{EXC}} \times \text{System Gain} = \text{RX10K Voltage Output (V)}$$

The Transmitter Excitation Voltage (V_{Exc}) to the gage is 2.5 VDC. The Gage Factor is specified by the gage manufacturer but is typically about 2.0. See Appendix B for Full Scale torque and output scaling equations and sample calculations.

Output Offset

The Output Offset allows the user to adjust the offset or “move the zero” of the output from the RX10K. The adjustment value displayed on the right is the actual output offset value in millivolts. The adjustment range is from $-12000mV$ to $+12000mV$ ($\pm 12V$), meaning the zero can be moved anywhere within the output range.

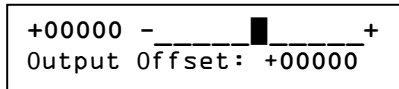

This adjustment affects the display output, the Voltage Output signal, and the digital (RS-232) output signal. The Output Offset value is applied to the signal after the Gain adjustment; therefore, the Gain adjustment may affect the zero output signal.

User Default

The RX10K parameters can be returned to their default settings. Holding down the **ADJUST ▲** key while powering up the RX10K resets the RX10K to the default values listed below.

<u>Default</u>	<u>Description</u>
Rx Ch	1
Input	Transmitter
Filter	500Hz
Input AutoZero	Off
Polarity	Positive
Gain	T=S
Output Offset	0

NOTE: All settings and offsets will be retained when power is cycled on the receiver.

Signal Processing

The TX10K-S data signal is processed by the RX10K as follows:

1. Receive signal from TX10K-S
2. Check for errors and display if any detected
3. Check for simulated signal and apply if enabled
4. Apply Filter
5. Apply AutoZero
6. Apply Polarity
7. Apply Gain
8. Apply Output Offset
9. Send signal to display, voltage output, and digital output

TX10K-S Transmitter

The TX10K-S Transmitter is encased in a tough nylon housing with a V-groove on the bottom for improved shaft alignment and an indentation on the top to guide fiberglass reinforced strapping tape installation. The TX10K-S also features a Status Indicator light, an Infrared Receiver lens, a Transmitter Antenna connector, and a screw terminal block for making power and sensor input connections.

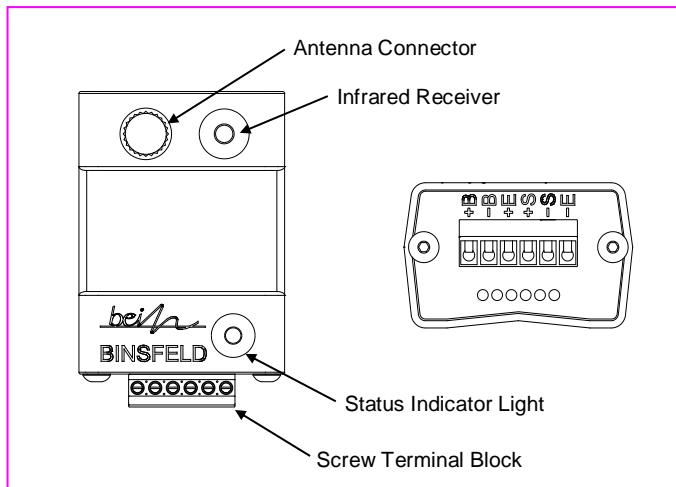

Figure 3: TX10K-S Transmitter

The TX10K-S can be configured even while it is installed (but not rotating) using the RM10K Remote Control. The TX10K-S has sixteen RF Channel settings and six Gain settings (500, 1000, 2000, 4000, 8000, and 16000). It can send low and high reference signals to the RX10K: internal precision shunt resistors simulate strain values that can be used to check calibration (refer to Appendix A for specifications).

NOTE: Make certain the Infrared Receiver lens remains unobstructed so that data can be received from the RM10K Remote Control.

Status Indicator Light

When the TX10K-S is powered up, it cycles through a startup sequence. It transmits four reference signals (the low and high strain values, positive and negative) and the green Status Indicator light on the TX10K-S flashes. Once the Status Indicator is on solid, it is in normal operating mode (transmitting actual data from the sensor). An error is indicated when the light is flashing, flickering or off as described below.

Indication

Off continuously

TX10K-S Status

No power applied; power polarity is reversed; battery is dead; or the transmitter is in Standby mode.

One flash off for ½ second

A Gain or Channel command has been received from the RM10K Remote Control.

Another flash off for ½ second

The Gain or Channel command has been carried out.
NOTE: If there is only one flash when changing Gain or Channel, then the high or low limit has been reached and cannot change any further in that direction.

Fast flash (7 Hz)	The input signal to the TX10K-S is out of range. Reducing the Gain will increase the input range and may eliminate this problem. NOTE: If the out-of-range condition is of a short duration, there may only be one or two flashes.
Slow flash (2 Hz)	One of the References (shunts) is enabled. NOTE: If a signal out of range condition occurs while the Reference is enabled, the light will indicate the out of range condition (fast flash).
Flicker off once every second	The power input voltage is either too high or too low. NOTE: Improper operation or damage to the transmitter can occur if operated outside its specified power input voltage range.

RM10K Remote Control

The handheld RM10K Remote Control allows the user to configure the TX10K-S Transmitter even while it is installed. The RM10K keypad operates similar to a common TV remote control, emitting an infrared signal through the window on the front of the unit. Simply point the RM10K at the Infrared Receiver on the TX10K-S and press the proper key to change the configuration. Both the Infrared Receiver lens and the window on the front of the RM10K need to be kept clean in order to function properly.

NOTE: The RM10K is designed to transmit commands to the transmitter when it is stationary. It will work at slow rotation speeds, typically less than 100 rpm.

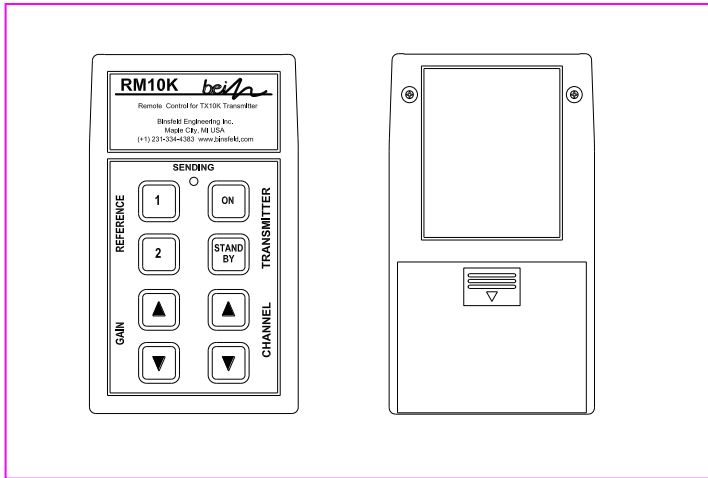

Figure 4: RM10K Remote Control

Battery Installation

Slide the battery access cover on the back of the RM10K enclosure in the direction of the arrow to open. Remove the old battery if present. Install a new 9V battery and slide the cover back into place.

Operational Distance Settings

Typically, the RM10K needs to be within 6 inches (150 mm) of the TX10K-S for the signal to be received. This normal (low infrared power) mode is intended to reduce the possibility of inadvertently changing the configuration of the TX10K-S by accidentally pressing a key on the RM10K. It also reduces the chance of changing the configuration of other transmitters in a multiple-transmitter installation.

The RM10K also has a high infrared power mode. This mode is useful when access to the TX10K-S is difficult or dangerous. Line-of-sight distances of 20 feet (6 meters) or more are feasible. The infrared signal will reflect off bright or shiny surfaces, making non-line-of-sight operation possible in some situations.

To enable the high infrared power mode, first press and release the **TRANSMITTER ON** key and then press the desired function key. When the **TRANSMITTER ON** key is pressed, the green **SENDING** light on the RM10K will come on for about 3 seconds.

The desired function key must be pressed within this 3-second timeframe; otherwise the RM10K will revert back to normal (low infrared power) mode. To send the ON command in high power mode, press the **TRANSMITTER ON** key twice.

The Infrared Receiver on the TX10K-S has an automatic gain control. Under bright light, it will become less sensitive, and the operational distance will be decreased. If the TX10K-S is not receiving commands from the RM10K, try shading the Infrared Receiver from direct, bright light.

RM10K Key Functions

A summary of each of the RM10K key functions and indicator light operation appears below.

TRANSMITTER ON

Brings the TX10K-S out of Standby mode or temporarily enables high infrared power mode.

TRANSMITTER STANDBY

Switches the TX10K-S into a low-power Standby mode to conserve the battery. No signal is transmitted while in Standby mode. The Status Indicator light on the TX10K-S turns off. The TX10K-S ignores all commands from the RM10K except **TRANSMITTER ON**. Disconnecting and reconnecting the 9V battery or activating **TRANSMITTER ON** brings the TX10K-S out of Standby mode.

REFERENCE 1

Activates the Reference 1 input signal or shunt resistor on the TX10K-S for 5 seconds. With a 350 Ω gage and 2.0 gage factor, the value simulates input strain equivalent to 100 microstrain in the positive direction. If this key is held down, the Reference will stay activated. If the key is pressed again within the 5 seconds, the Reference will remain activated for another 5 seconds (see Appendix A.)

REFERENCE 2

Operation is the same as Reference 1 but simulates a 500 microstrain input in the positive direction with a 350 Ω gage and 2.0 Gage Factor (see Appendix A).

GAIN ▲

Increases the gain setting of the TX10K-S. If the Transmitter Gain is already at the maximum value, the Status Indicator on the TX10K-S will flash only once, indicating the command was received but not carried out.

GAIN ▼

Decreases the gain setting of the TX10K-S. If the gain is already at the minimum value, the Status Indicator on the TX10K-S will flash only once, indicating the command was received but not carried out.

CHANNEL ▲

Increases the RF channel of the TX10K-S. If the channel is already at the maximum value, the Status Indicator on the TX10K-S will flash only once, indicating the command was received but not carried out.

CHANNEL ▼

Decreases the RF channel of the TX10K-S. If the channel is already at the minimum value, the Status Indicator on the TX10K-S will flash only once, indicating the command was received but not carried out.

SENDING Light

The SENDING light will come on for about 1 second when a key is pressed. This indicates the RM10K is sending a signal. It is not an indication that the TX10K-S has received the signal. The Status Indicator on the TX10K-S or the display on the RX10K can be monitored to confirm successful command transmission.

If the SENDING light flashes after a key is pressed, the battery in the RM10K is low and should be replaced. If the SENDING light does not come on at all after a key is pressed, the battery is dead and needs to be replaced.

As mentioned in the previous section, the SENDING light will stay on for about 3 seconds after the **TRANSMITTER ON** key has been pressed. This indicates the RM10K is in high power mode, and any command sent during the next 3 seconds will be at the high infrared power level.

Multiple TX10K-S Transmitters

When working with multiple TX10K-S Transmitters in close proximity, the Infrared Receivers may be intentionally covered with an opaque object in order to eliminate an inadvertent configuration change to an adjacent TX10K-S. Also, removing power (disconnecting the battery) or putting the TX10K-S in standby mode will prevent the RM10K from changing the configuration of a transmitter.

Product Safety

The user assumes all risk and liability for the installation and operation of this equipment. Each application presents its own hazards. Typically, certain system components are strapped to a rotating shaft. If sufficient care is not taken to properly secure these components or accessories connected to them, they can be flung from the shaft, causing damage to the components or to property or persons in the vicinity. Use more than enough tape: 10 or more wraps is not too much.

Installation Procedure

The TorqueTrak 10K System is designed for ease of use. The procedure for a typical setup on a shaft for obtaining torque measurements is detailed in the *Field Testing* section below.

It is recommended that the user bench test the instrument to become familiar with the various operational features prior to conducting tests in the field. The BS900 Bridge Simulator and 9V Battery Connector have been provided for this purpose. See the *Bench Testing* section for details.

Field Testing

Although the settings of the TX10K-S can be changed during operation of the system, it is best to determine the appropriate Transmitter Gain setting for a given application prior to installation. Refer to Appendix B for the relevant calculations.

1. Attach sensor or strain gage to the shaft (or other surface) where the desired strain will be measured. Refer to Appendix D for instructions on strain gage application.
2. Remove cover from BH10K Battery Housing. Snap fresh 9V battery onto snaps and place into BH10K. Secure cover with screws with re-usable vibration-resistant coating. Make sure that the cover and screws are tightly fastened.

NOTE: The BH10K is most useful when testing extends beyond the life of the battery, allowing replacement without removal from the shaft. Alternatively, the 9V Battery Connector can be used. In this case, skip step 4.

3. Screw Transmitter Antenna onto TX10K-S Transmitter. Secure TX10K-S and BH10K (or battery) to shaft using fiberglass reinforced strapping tape. Align V-groove on bottom axially with shaft and tape across indentation in top. Do not cover TX10K-S Infrared Receiver or Status Indicator. Alternatively, hose clamps, machined collars, or other mounting devices may be used but avoid excessive compression.

CAUTION: Be certain all components are fixed firmly to moving surfaces. The Transmitter and battery holder have a groove for the fiberglass reinforced strapping tape, which should be wrapped around at least 10 times (5 times in each direction) to secure the components to the shaft. The open end of the tape should follow shaft rotation. For extra protection, glue the end of the tape down. When finished with testing cut the tape and remove components. Avoid the risk of being struck by improperly secured objects flung from the machine by standing clear during operation!

NOTE 1: This method of securing the transmitter and battery holder is for **temporary use only**. For long term use this tape should be examined frequently for the effects of environmental influences (e.g.: excessive oils) or extreme conditions (e.g.: rapid starts/stops, high temperatures).

Replace tape as required following the notes in the "CAUTION" previously listed.

NOTE 2: If the shaft is small (≤ 1 " or 25 mm), balance might be an issue. In this case, steps may have to be taken to balance the transmitter (TX10K) and the battery and housing (BH10K). Please discuss this with your Binsfeld Engineering Sales Representative.

4. Cut an appropriate length of 2-conductor power cable (red & black twisted pair) and strip and tin ends. Connect red wire to **+B** on BH10K and to **+B** on TX10K-S and black wire to **-B** on BH10K and to **-B** on TX10K-S. The Status Indicator light should blink several times and then come on solid. Secure to shaft.

NOTE: If testing will not begin for some time, use the RM10K Remote Control to put the TX10K-S in Standby mode to save battery life. The Status Indicator light will turn off. A fresh battery will last for several days in this mode.

5. Cut an appropriate length of 4-conductor ribbon cable (as short as practical to avoid unwanted electrical noise) and strip and tin ends. Solder to gage per Appendix D or gage manufacturer's specification and make appropriate connections to the TX10K-S terminals. Secure loose cable to shaft.
6. Connect Receiver Antenna to **Antenna** connector on the rear panel of the RX10K Receiver. Position magnetic-mount antenna with element installed near the TX10K-S, typically within 10 feet (3 meters).
7. Insert connector on AC/DC adapter into **Power Input** jack on the RX10K rear panel. Plug adapter into appropriate AC power source (i.e., wall socket). Flip the RX10K power switch to **On** while holding down the **ADJUST ▲** key.

NOTE: This resets the RX10K parameters to their default settings. Simply turn **On** without holding any keys if previously set parameter configurations are desired.

8. Turn on the TX10K-S with the RM10K (if needed). Confirm that Status Indicator light is on solid. Slowly scroll through each RX10K channel until it matches TX10K-S channel setting (top line will quit flashing and bottom line will show the

RF signal strength). Change both units to desired channel and verify adequate signal strength. If possible, rotate the TX10K-S through complete range of motion to verify strong signal reception in all orientations.

9. Scroll RX10K display to Gain parameter screen. Use the RM10K to configure the Transmitter Gain to the appropriate level.
10. Scroll RX10K display to Input AutoZero parameter screen. Apply AutoZero with no load on the shaft to zero-out any initial gage offset. Press and hold **ADJUST ▲** key for 2 seconds until bottom line reads "Input AutoZero: On". AutoZero can be reset by turning off and then on again.

NOTE: Once AutoZero is activated, the initial gage offset is subtracted from the output, which has a maximum range of ± 12 V. The extra ± 2 V overhead above and below Full Scale (± 10 V) is provided to help minimize this reduction in range. For example, if the initial offset is 1.6 V, then the maximum output of the system will be 10.4 V after AutoZero is set. This still allows for strain measurement up to Full Scale.

If before activating AutoZero there is an initial offset of more than 50% of Full Scale, it may be necessary to 1) use a lower Transmitter Gain setting, 2) apply a shunt resistor to balance the gage, or 3) replace the strain gage. For further assistance, contact Binsfeld Engineering Inc.

11. Scroll RX10K display to Filter parameter screen. Set the Filter to the desired level.
12. Scroll RX10K display to Gain parameter screen. Set the System Gain to scale and/or calibrate output based on calculations as demonstrated in Appendix B. Check calibration by using the RM10K to command the TX10K-S to transmit **REFERENCE 1** and/or **2** to the RX10K.
13. Connect appropriate recording device to either the analog **Voltage Output** terminals or digital **Com** (DB9) connector. Check the zero and adjust using the Output Offset if needed.
14. The system is now ready to record data.

Bench Testing

1. Connect Receiver Antenna to **Antenna** connector on the rear panel of the RX10K Receiver. Position magnetic-mount antenna with element installed near the TX10K-S.
2. Insert connector on AC/DC adapter into **Power Input** jack on the RX10K rear panel. Plug adapter into appropriate AC power source (i.e., wall socket). Flip the RX10K power switch to **On** while holding down the **ADJUST ▲** key.

NOTE: This resets the factory default parameter settings. Values reported in this section may be different if default values are not reset.

3. Attach 9V Battery Connector to TX10K-S Transmitter (red to **+B**, black to **-B**). Attach BS900 Bridge Simulator to the TX10K-S terminals **+/- E** and **+/- S** to coincide with pins on BS900. Clip 9V battery to connector.
4. Slowly scroll through each RX10K channel until it matches TX10K-S channel setting (top line will quit flashing and bottom line will show the RF signal strength). Change both units to desired channel and verify adequate signal strength. (To configure TX10K-S settings, use the RM10K Remote Control.)
5. Scroll RX10K display to Gain parameter screen. Use the RM10K to configure the Transmitter Gain to 4000 ("Gain T:04000 S:04000").
6. Scroll RX10K display to Input AutoZero parameter screen. Apply AutoZero with BS900 in center or zero (**0**) position. Press and hold **ADJUST ▲** key for 2 seconds until bottom line reads "Input AutoZero: On".
7. Switch BS900 to the positive (+) position. RX10K output should be close to +2V ("02000") and the bar graph indicator should move one segment to the right of zero ("0").
8. Switch BS900 to the negative (-) position. RX10K output should be close to -2V ("-02000") and the bar graph indicator should move one segment to the left of zero ("0").

NOTE: The BS900 Bridge Simulator is not a calibrated reference. Its purpose is to provide a full bridge circuit to the TX10K-S to verify functionality and assist in troubleshooting.

9. Use the RM10K to command the TX10K-S to transmit **REFERENCE 1**. RX10K output should be close to +2V (“+02000”) and the bar graph indicator should move one segment to the right of zero (“0”) for a duration of 5 seconds.

Calibration

The TorqueTrak 10K System is calibrated prior to shipping using instruments traceable to the United States National Institute of Standards and Technology (NIST). Calibration can be checked at any time with a NIST traceable reference such as a calibrated voltmeter with sufficient (millivolt) resolution.

To verify calibration of the RX10K Receiver:

1. Insert connector on AC/DC adapter into **Power Input** jack on the RX10K rear panel (refer to Figure 2 on page 6). Plug adapter into appropriate AC power source (i.e., wall socket). Flip the RX10K power switch to **On** while holding down the **ADJUST ▲** key.
2. Allow the RX10K to warm up for 15 minutes.
3. Connect a calibrated, high-accuracy voltmeter to the **Voltage Output** terminals.
4. Scroll RX10K display to Input parameter screen. Press the **ADJUST ▲** key to scroll through the simulated inputs and check the outputs.

<u>Input</u>	<u>Output</u>
+FS	10.000 ± .010 VDC
Zero	0.000 ± .005 VDC
-FS	-10.000 ± .010 VDC
+FS/2	5.000 ± .005 VDC
-FS/2	-5.000 ± .005 VDC
+FS/4	2.500 ± .005 VDC
-FS/4	-2.500 ± .005 VDC

It is recommended that the system be checked for calibration annually. If found to be out of specification, it can be returned to Binsfeld Engineering Inc. for calibration for a nominal fee (\$170.00, price subject to change).

Warranty and Service Information

LIMITED WARRANTY

Binsfeld Engineering Inc. warrants that its products will be free from defective material and workmanship for a period of one year from the date of delivery to the original purchaser and that its products will conform to specifications and standards published by Binsfeld Engineering Inc. Upon evaluation by Binsfeld Engineering Inc., any product found to be defective will be replaced or repaired at the sole discretion of Binsfeld Engineering Inc. Our warranty is limited to the foregoing, and does not apply to fuses, paint, or any equipment, which in Binsfeld Engineering's sole opinion has been subject to misuse, alteration, or abnormal conditions of operation or handling.

This warranty is exclusive and in lieu of all other warranties, expressed or implied, including but not limited to any implied warranty of merchantability or fitness for a particular purpose or use. Binsfeld Engineering Inc. will not be liable for any special, indirect, incidental or consequential damages or loss, whether in contract, tort, or otherwise.

NOTE (USA only): Some states do not allow limitation of implied warranties, or the exclusion of incidental or consequential damages so the above limitations or exclusions may not apply to you. This warranty gives you specific legal rights and you may have other rights which vary from state to state.

For service please contact Binsfeld Engineering Inc.:

4571 W. MacFarlane Road
Maple City, MI 49664
Phone: (+1) 231-334-4383
Fax: (+1) 231-334-4903
Internet: www.binsfeld.com
Email: sales@binsfeld.com

FCC Rules Part 15: Computing Devices

TRADE NAME:	Torque Telemetry System
COMPLIANCE TEST REPORT NUMBERS:	B70309A1 Model: RM10K B70321A1 Model: RX10K B70517B1 Model: TX10K
COMPLIANCE TEST REPORT DATE:	May 22, 2007
RESPONSIBLE PARTY (IN USA):	Stephen Tarsa
ADDRESS:	4571 W. MacFarlane Road Maple City, MI 49664 USA
TELEPHONE:	(+1) 231-334-4383

This equipment has been tested and found to comply with the limits for a Class B digital device, pursuant to part 15 of the FCC Rules. These limits are designed to provide reasonable protection against harmful interference in a residential installation. This equipment generates, uses, and can radiate radio frequency energy and, if not installed and used in accordance with the instructions, may cause harmful interference to radio communications. However, there is no guarantee that interference will not occur in a particular installation. If this equipment does cause harmful interference to radio or television reception, which can be determined by turning the equipment off and on, the user is encouraged to try to correct the interference by one or more of the following measures:

- Reorient or relocate the receiving antenna.
- Increase the separation between the equipment and the receiver.
- Connect the equipment into an outlet on a circuit different from that to which the receiver is connected.
- Consult the dealer or an experienced radio/TV technician for help.

In order to maintain compliance with FCC regulations, shielded cables must be used with this equipment. Operation with non-approved equipment or unshielded cables is likely to result in interference to radio and TV reception. The user is cautioned that changes and modifications made to the equipment without approval of manufacturer could void the user's authority to operate this equipment.

Operation is subject to the following two conditions: (1) this device may not cause interference, and (2) this device must accept any interference that may cause undesired operation of the device.

I, the undersigned, hereby declare that the equipment specified above conforms to the above requirements.

Place: Maple City, MI Date: April 14, 2016

Signature:



Stephen Tarsa, CEO

Appendix A: TorqueTrak 10K Specifications

TT10K-S Transmitter

Power supply voltage	7 to 18 Vdc
Power supply current ¹	
Transmit mode	40 mA (nom), 50 mA (max)
Standby mode	4 mA (nom), 5 mA (max)
9V Ultralife lithium battery life ¹	
Transmit mode	24 hours (typ)
Standby mode	240 hours (est)
Bridge excitation voltage	2.50 VDC ($\pm 0.1\%$, 10ppm/ $^{\circ}$ C)
Available output current	20 mA (max) to sensor
Input voltage range (\pm S to -E)	0.2 to 3.9 V
Offset error ²	$\pm 0.16\%$ FS max 25 $^{\circ}$ C ambient
Offset temperature coefficient ²	$\pm 0.004\%$ FS/ $^{\circ}$ C max 0-50 $^{\circ}$ C amb
Gain error ²	$\pm 0.25\%$ R max 25 $^{\circ}$ C ambient
Gain temperature coefficient ²	$\pm 0.005\%$ R/ $^{\circ}$ C max 0-50 $^{\circ}$ C amb
Shunt resistor (Reference 1)	437400 Ω , $\pm 0.1\%$, 25 ppm/ $^{\circ}$ C
Shunt resistor (Reference 2)	87370 Ω , $\pm 0.1\%$, 25 ppm/ $^{\circ}$ C
Simulated torque strain (350 Ω bridge, GF = 2.0)	
Shunt resistor (Ref 1)	100 microstrain ($\mu\epsilon$)
Shunt resistor (Ref 2)	500 microstrain ($\mu\epsilon$)
Note: TX10K gain levels 500, 1000 and 2000 are calibrated using shunt resistor Reference 2. Gain levels 4000, 8000 and 16000 are calibrated using shunt resistor Reference 1.	
All gain levels are calibrated with a 350 Ω bridge.	
Antenna connection	Reverse SMA
G-force	3000 G's (max continuous)
Operating temperature range	-30 to 85 $^{\circ}$ C (-22 to 185 $^{\circ}$ F)
Size (without antenna)	1.00" x 1.63" x 2.50" (25 mm x 41 mm x 64 mm)
Note: height increases to 2.63" (67 mm) with antenna	
Weight	3 oz (85 grams)

Screw Terminal Connector

1	+B	Positive Battery or DC power supply input
2	-B	Negative Battery or DC power supply input
3	+E	Positive Excitation or voltage output
4	+S	Positive Sense or voltage input
5	-S	Negative Sense or voltage input
6	-E	Negative Excitation voltage output (internally connected to -B)

**Sensor Input Range for Torque or Bending
Full Bridge, 4 Active Arms**

TX10K-S Gain Setting	Full Scale Strain ($\mu\epsilon$)	Full Scale Input (mV)	System Gain (V/V)		
			Min (0.25x)	Nom	Max (4.0x)
500	± 4000	± 20	125	500	2000
1000	± 2000	± 10	250	1000	4000
2000	± 1000	± 5	500	2000	8000
4000	± 500	± 2.5	1000	4000	16000
8000	± 250	± 1.25	2000	8000	32000
16000	± 125	± 0.625	4000	16000	64000

**Sensor Input Range for Axial Strain
Full Bridge, 2.6 Active Arms**

TX10K-S Gain Setting	Full Scale Strain ($\mu\epsilon$)	Full Scale Input (mV)	System Gain (V/V)		
			Min (0.25x)	Nom	Max (4.0x)
500	± 6154	± 20	125	500	2000
1000	± 3077	± 10	250	1000	4000
2000	± 1538	± 5	500	2000	8000
4000	± 769	± 2.5	1000	4000	16000
8000	± 385	± 1.25	2000	8000	32000
16000	± 192	± 0.625	4000	16000	64000

**Sensor Input Range
 $\frac{1}{4}$ Bridge, 1 Active Arm**

TX10K-S Gain Setting	Full Scale Strain ($\mu\epsilon$)	Full Scale Input (mV)	System Gain (V/V)		
			Min (0.25x)	Nom	Max (4.0x)
500	± 16000	± 20	125	500	2000
1000	± 8000	± 10	250	1000	4000
2000	± 4000	± 5	500	2000	8000
4000	± 2000	± 2.5	1000	4000	16000
8000	± 1000	± 1.25	2000	8000	32000
16000	± 500	± 0.625	4000	16000	64000

RM10K Remote Control

Power supply	9 V battery (supplied)
Pulsed infrared frequency	38 KHz
Transmission distance (line-of-sight)	
Normal mode	6 in (150mm, typ)
High power mode	10 ft (3 m, typ)
Operating temperature range (Battery-limited)	-20 to 60°C (-4 to 140°F)
Size	0.88" x 2.5" x 4.4" (22 mm x 63 mm x 112 mm)
Weight (with battery)	4 oz (113 grams, typ)

BH10K Battery Holder

Size	1.00" x 1.63" x 2.50" (25 mm x 41 mm x 64 mm)
Weight (with battery)	3 oz (85 grams, typ)

Screw Terminal Connector

1	+B	Positive Battery output
2	-B	Negative Battery output

RX10K Receiver

Analog voltage output signal	
Nominal range	±10 V
Maximum range	±12 V
Analog output connection	5-way binding posts
Analog output impedance	50Ω
System Gain adjustment	0.25 to 4.0 x Transmitter Gain
Offset adjustment	±10 V
Display	2-line x 20 character high contrast LCD w/backlight
Power input	10 to 18 VDC @ 300mA (max)
(110 or 220VAC adapter included)	
Antenna input connection	SMA
Power input connector	2.1 mm jack (5.5 mm x 2.1 mm plug)
Operating temperature range	-20 to 70°C (-4 to 158°F)

Size	2.88" x 5.75" x 8.50" (73 mm x 146 mm x 216 mm)
Weight	2 lb (1 kg)

Digital Output (Com) Specification

The TT10K system includes a streaming digital output port on the rear panel of the RX10K Receiver. This output is RS-232 type data. A DB9 male-female cable is supplied for direct connection to a PC Com port.

Pin out for the DB9 connector on the RX10K

1		
2	TXD	Data output
3		
4		
5	GND	Ground or common connection
6		
7		
8		
9		

PC COM Port Settings

Bits per second	115200
Data bits	8
Parity	none
Stop bits	1
Flow control	none

Sample Protocol

The output sample rate is 2400 samples per second. There are 4 bytes sent for each sample:

1	Start byte	ASCII 'SOH' code (hex 01)
2	Sample data low byte	
3	Sample data high byte	
4	Stop byte	ASCII 'CR' code (hex 0D)

The sample data is sent as a 16 bit signed integer:

$$Dout = Vin \times Asys \times 1000$$

Dout = streaming digital output sample data

Vin = TX10K transmitter voltage input (gage or sensor voltage)

Asys = TT10K system gain factor

TorqueTrak 10K Telemetry System

Resolution	14 bits
Sample transmission rate	2400 Hz
Signal bandwidth ³	500 Hz (-3dB)
Signal to noise ratio ^{2,3}	67 dB (min)
Signal delay ³	4.2 mS (typ)
(transmitter input to voltage output)	
RF transmission distance	20 ft (6 m) line-of-sight (typ)
Gain error	0.25%R (max) @ 25°C
Gain drift ²	0.005%R/°C (max) 0-50°C
Zero error ²	0.16%FS (max) @ 25°C
Zero drift ²	0.004%FS/°C (max) 0-50°C

RF Channel Frequencies Table

RF Channel	Frequency (MHz)	RF Channel	Frequency (MHz)
1	902.62	9	914.62
2	904.12	10	916.12
3	905.62	11	917.62
4	907.12	12	919.12
5	908.62	13	920.62
6	910.12	14	922.12
7	911.62	15	923.62
8	913.12	16	925.12

Note: For best performance, use Channels 1-8 when operating at high temperatures

NOTES:

All specifications subject to change.

¹ Measured with 350Ω bridge

² TX10K-S Transmitter gain level = 4000

³ RX10K filter set at 500 Hz

Pelican™ case details:

Outer dimensions: 20" x 14" x 5" (508mm x 356mm x 127mm)

Shipping weight: 13 lbs (5.9 kg)

Appendix B: Calibration Calculations

The equations in this Appendix define the relationship between the input signal to the TX10K-S Transmitter (typically from a strain gage) and the Full Scale output voltage of the TorqueTrak 10K System. The calculations are based on parameters of the device being measured (e.g. shaft diameter), sensor parameters (e.g. gage factor) and Transmitter Gain setting.

Section B1 is specific to torque measurements on round shafts (full bridge, 4 active arms).

Section B2 applies to axial strain (tension/compression) measurements on round shafts (full bridge, 2.6 active arms).

Section B3 is for use with a single grid (1/4 bridge).

1 $\mu\epsilon$ is distortion of the shaft surface 1×10^{-6} in/in. For more technical information regarding the relationship between shear strain and torque, see the excellent technical article [TN-512 published by Vishay](#).

B1: Torque on Round Shafts

Step 1: Calculate Full Scale Torque, T_{FS} (ft-lb)

The Full Scale Torque corresponds to a system output of 10 V. For a solid steel shaft, use the calculator on our website at www.binsfeld.com or use the simplified equation below:

$$\frac{(1510.38 \times 10^3 \text{ ft-lb/in}^3)(D_o^3)}{(GF) (G_{XMT})} = T_{FS} \text{ (ft-lb)}$$

For all other shafts use the more general equation:

$$\frac{(V_{FS})(\pi)(E)(4)(D_o^4 - D_i^4)}{(V_{EXC})(GF)(N)(16)(1+\nu)(G_{XMT})(D_o)(12)} = T_{FS} \text{ (ft-lb)}$$

For metric applications with D_o and D_i in millimeters and T_{FS} in N-m, the general equation is:

$$\frac{(V_{FS})(\pi)(E)(4)(D_o^4 - D_i^4)}{(V_{EXC})(GF)(N)(16000)(1+\nu)(G_{XMT})(D_o)} = T_{FS} \text{ (N-m)}$$

Where $E = 206.8 \times 10^3 \text{ N/mm}^2$

Legend of Terms	
D_i	Shaft Inner Diameter (in) (zero for solid shafts)
D_o	Shaft Outer Diameter (in)
E	Modulus of Elasticity (30×10^6 PSI steel)
GF	Gage Factor (specified on strain gage package)
G_{XMT}	Telemetry Transmitter Gain (user configurable, typical is 4000 for ± 500 microstrain range)
N	Number of Active Gages (4 for torque)
T_{FS}	Full Scale Torque (ft-lb)
V_{EXC}	Bridge Excitation Voltage = 2.5 volts
V_{FS}	Full Scale Output of System = 10 volts
ν	Poisson's Ratio (0.30 for steel)

For example, given a solid steel shaft with:

D_O (shaft Outer Diameter, measured) = 3.000 inches
GF (Gage Factor from gage package) = 2.08
G_{XMT} (TX10K-S Gain setting) = 4000

$$T_{FS} = \frac{(1510.38 \times 10^3 \text{ ft-lb/in}^3)(3.000 \text{ in})^3}{(2.08)(4000)} = 4,901 \text{ ft-lb}$$

so 10 V output from the RX10K indicates 4,901 ft-lb of torque or 490.1 ft-lb/volt.

Step 2: Scale the Full Scale Output

If desired, the Full Scale voltage output of the TX10K can be scaled so that it corresponds to a convenient torque value, e.g. 100 ft-lb/volt. As stated earlier, the System Gain can be adjusted from ¼ to 4 times the Transmitter Gain. The equation below defines the Scale Factor (Z):

$$Z = \frac{T_{FS}}{T_{REF}}$$

Legend of Terms	
Z	Scale Factor (0.25 to 4.0)
T _{FS}	Full Scale Torque (ft-lb)
T _{REF}	Reference Full Scale Torque (ft-lb)

In the example from Step 1 above, Full Scale Torque (T_{FS}) has been calculated to be 4,901 ft-lb. It may be convenient to scale the output so that 10 V indicates 5,000 ft-lb (1 V = 500.0 ft-lb). First, calculate the Scale Factor (Z):

$$\frac{4,901 \text{ ft-lb}}{5,000 \text{ ft-lb}} = Z = 0.9802$$

Next, multiply the Scale Factor times the Transmitter Gain setting to find the System Gain setting.

$$4000 \times 0.9802 = 3920$$

Scroll to the Gain parameter screen on the RX10K and set the System Gain to 3920 (see page 9). In summary:

Before adjusting full scale output:

$$4,901 \text{ ft-lb} = 10.000 \text{ V (490.1 ft-lb/volt)}$$

After adjusting full scale output:

$$5,000 \text{ ft-lb} = 10.000 \text{ V (500.0 ft-lb/volt)}$$

Step 3: Calibrate the Output

There are two ways to perform a calibration of the installation: a deadweight calibration or shunt calibration.

Deadweight Calibration

The most precise method is to perform a deadweight calibration. This involves suspending a known mass a known horizontal distance from the center of the shaft. This is not always practical but does take into account all possible deviation in the system (actual material properties versus data sheet, shaft geometry, gage imbalance, etc.) With the known moment applied, adjust the System Gain until the output is the same as the calculated torque value.

Using the parameters outlined in the previous example, a deadweight is applied to the gaged 3-inch shaft that corresponds to 500 ft-lb of torque. The System Gain would be adjusted until the output was equal to 1 volt. NOTE: It is recommended that in order to be meaningful, the deadweight should create a torque load close to those expected during testing. At a minimum, they should represent at least 10% of the range.

Shunt Calibration

The more common method is to perform a shunt calibration. This method takes into account deviations in the setup from the strain gage to the transmitter, but unlike a deadweight calibration, none of the deviations in the physical parameters.

The easiest way to conduct a shunt calibration is by enabling one of the reference shunt resistors on-board the TX10K-S. An internal precision resistor is placed in parallel with one arm of the bridge to simulate a precise strain value. As stated earlier, Reference 1 simulates 100 microstrain ($\mu\epsilon$) and Reference 2 simulates 500 $\mu\epsilon$ when using a 350 Ω strain gage with a Gage Factor of 2.0. Alternatively, precision resistors can be placed in parallel with one arm of the bridge to simulate a torque load. The Tech Info section on our website (www.binsfeld.com) has a helpful Torque Strain Calculator to assist in determining the strain a given resistor value simulates. The equation relating strain and shunt resistance is shown below:

$$R_C = \frac{R_G}{(N)(GF)(\epsilon)}$$

Legend of Terms	
R_C	Shunt Calibration Resistance (k Ω)
R_G	Gage Resistance (Ω)
N	Number of Active Gages
GF	Gage Factor
ϵ	Strain ($\mu\epsilon$)

In the example from Steps 1 & 2, the Full Scale Torque is 4,901 ft-lb and the RX10K output has been scaled so that 10 V corresponds to a torque load of 5,000 ft-lb by setting the System Gain to 3920. This was determined by multiplying the Transmitter Gain of 4000 ($\pm 500 \mu\epsilon$ range) by the Scale Factor (Z) that was calculated to be 0.9802.

First, determine what the system output should be when applying the shunt resistance. In this case, Reference 1 (100 $\mu\epsilon$) is a good

choice (20% of Full Scale). To calculate the calibrated output of the system, use the equation below:

$$V_S = \left(\frac{\epsilon_S}{\epsilon_{FS}} \right) (Z) (V_{FS})$$

Legend of Terms	
V_S	Voltage Output with Shunt Applied (V)
ϵ_S	Strain Simulated by Shunt ($\mu\epsilon$, GF = 2.0)
ϵ_{FS}	Full Scale Strain ($\mu\epsilon$, GF = 2.0)
Z	Scale Factor (one if no scaling)
V_{FS}	Full Scale Voltage Output (V) (10V)

In this example, with Reference 1 applied, the calibrated Voltage Output would be calculated as follows:

$$\left(\frac{100 \mu\epsilon}{500 \mu\epsilon} \right) (0.9802) (10 V) = V_S = 1.9604 V$$

Adjust the System Gain setting until the output matches this value. The adjustment is typically small (<0.5%). The system is now ready to measure torque with the desired output scaling.

NOTE: When the Gage Factor is not 2.0, the actual Full Scale Strain and Simulated Strain values are affected proportionately. In the example above with a Gage Factor of 2.08, Full Scale Strain is technically 480.7 $\mu\epsilon$, not 500. However, the Simulated Strain is likewise affected (Ref 1 becomes 96.14 $\mu\epsilon$, not 100). The ratio of Simulated Strain to Full Scale Strain remains constant (20%) and the calculation above remains valid.

Also, if the gage resistance is not 350 Ω , the Reference 1 & 2 Simulated Strain values are not 100 and 500 $\mu\epsilon$, respectively. Use our online calculator or the equation on page 33 to calculate the simulated strain in this instance (use GF = 2.0).

B2: Axial Strain on Round Shafts

Step 1: Calculate Full Scale Forces P_{FS} (lb) that corresponds to the maximum system output of 10.0V.

For a solid steel shaft, use this simplified equation:

$$\frac{(145 \times 10^6 \text{ lb/in}^2)(D_o^2)}{(GF) (G_{XMT})} = P_{FS}$$

For all other shafts use the more general equation:

$$\frac{(V_{FS})(\pi)(E)(D_o^2 - D_i^2)}{(V_{EXC})(GF)(2)(1+\nu)(G_{XMT})} = P_{FS}$$

Legend of Terms	
D_i	Shaft Inner Diameter (in) (zero for solid shafts)
D_o	Shaft Outer Diameter (in)
E	Modulus of Elasticity (30×10^6 PSI steel)
GF	Gage Factor (specified on strain gage package)
G_{XMT}	Telemetry Transmitter Gain (user configurable, typical is 4000 for ± 770 microstrain range)
P_{FS}	Full Scale Force (tension or compression) (lb)
V_{EXC}	Bridge Excitation Voltage = 2.5 volts
V_{FS}	Full Scale Output of System = 10 volts
ν	Poisson's Ratio (0.30 for steel)

Example: Given a solid steel shaft with
D_o (shaft Outer Diameter, measured) = 2.25 inches
GF (Gage Factor from gage package) = 2.045
G_{XMT} (TX10K-S Gain setting) = 4000

$$P_{FS} = \frac{(145 \times 10^6 \text{ lb/in}^2)(2.25 \text{ in})^2}{(2.045)(4000)} = 89,739 \text{ lb}$$

so 10 V output from the RX10K indicates 89,739 lb of force or
8974 lb/volt.

For information on output scaling and calibration, see section B1.

B3: Single Grid (1/4 Bridge)

Step 1: Calculate Full Scale Strain, ϵ_{FS} (inches/inch) that corresponds to the maximum system output of 10.0V.

$$\frac{(V_{FS})(4)}{(V_{EXC})(GF)(G_{XMT})} = \epsilon_{FS}$$

Using the values listed in the table below, this equation reduces to:

$$\frac{(16)}{(GF)(G_{XMT})} = \epsilon_{FS}$$

Legend of Terms	
ϵ_{FS}	Full Scale Strain (inches/inch; 10^{-6} inches/inch = 1 microstrain)
GF	Gage Factor (specified on strain gage package)
G_{XMT}	Telemetry Transmitter Gain (user configurable, typical is 4000 for ± 2000 microstrain range)
V_{EXC}	Bridge Excitation Voltage = 2.5 volts
V_{FS}	Full Scale Output of System = 10 volts

Example: GF (gage factor from gage package) = 2.045
 G_{XMT} (TX10K-S gain setting) = 4000

$$\epsilon_{FS} = \frac{(16)}{(2.045)(4000)} = 1956 \times 10^{-6} \text{ inches/inch}$$

so 10 V output from the RX10K indicates 1956 microstrain or 196 microstrain/volt.

For information on output scaling and calibration, see section B1.

Appendix C: Error Codes

Error Displayed

Tx Signal UnderRange

Tx Signal OverRange

Rx Signal UnderRange

Rx Signal OverRange

Tx->Rx Data Error

Tx Power Low Error

Tx Power High Error

Rx Power Low Error

Rx Power High Error

Error Detected

The input signal to the TX10K-S is less than the minimum level

The input signal to the TX10K-S is greater than the maximum level

The output signal of the RX10K is less than the minimum level

The output signal of the RX10K is greater than the maximum level

The signal from the TX10K-S is not being received properly by the RX10K

NOTE: The output signals of the RX10K will go to negative full scale (-12000mV)

The power supply voltage level of the TX10K-S is too low

The power supply voltage level of the TX10K-S is too high

The power supply voltage level of the RX10K is too low

The power supply voltage level of the RX10K is too high

Appendix D: Strain Gage Application

(Also refer to instruction bulletin B-127-12 provided with GAK-2-200 Strain Gage Application Kit from Vishay Measurements Group, Inc., Raleigh, NC, 919-365-3800, www.measurementsgroup.com.)

PREPARING THE SURFACE

1. A 3-inch square area will be used for gaging. Scrape off any paint or other coatings and inspect shaft for oil residue. If necessary, use a degreasing solution or isopropyl alcohol to remove.
2. Rough sand the gaging area with **220 grit paper**. Finish the sanding procedure by wetting the gaging area with **M-Prep Conditioner A** and the wetted surface with **400 grit paper** provided. Rinse by squirting with **M-Prep Conditioner A**. Wipe the area dry with **tissue** taking care to wipe in only one direction. Each time you wipe use a clean area of the tissue to eliminate contamination.
3. Rinse shaft this time by squirting with **M-Prep Neutralizer 5A**. Wipe the gaging area dry with a clean tissue, wiping in only one direction and using clean area of tissue with each wipe. Do not allow any solution to dry on the surface as this may leave a contaminating film which can reduce bonding. Surface is now prepared for bonding.

MARKING THE SHAFT FOR GAGE ALIGNMENT

4. The gage needs to be perpendicular to the shaft axis. In general, this can be accomplished by eye since misalignment of less than 4 degrees will not generate significant errors. For higher precision, we recommend two methods for marking the shaft:
 - a) Use a machinist square and permanent marker or scribe for perpendicular and parallel lines; or
 - b) Cut a strip of graph paper greater than the circumference of the shaft. Tape it to the shaft while lining up the edges. Mark desired gage position with a scribe or permanent marker.

PREPARING THE GAGE FOR MOUNTING

- Using tweezers, remove one gage from its package. Using the plastic gage box as a clean surface, place the gage on it, bonding side down. Take a 6" piece of **PCT-2M Mylar Tape** and place it on the gage and terminal, centered. Slowly lift the tape at a shallow angle. You should now have the gage attached to the tape.

POSITIONING THE GAGE

- Using the small triangles located on the four sides of the gage, place the taped gage on the shaft, perpendicular with the shaft axis, aligned with your guide marks. If it appears to be misaligned, lift one end of tape at a shallow angle until the assembly is free to realign. Keep one end of the tape firmly anchored. Repositioning can be done as the PCT-2M tape will retain its mastic when removed and therefore not contaminate the gaging area.

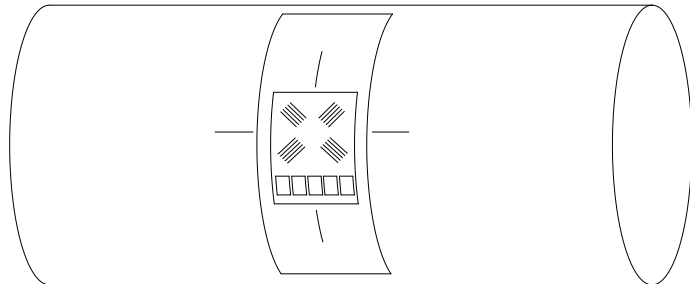

Positioning the Gage on the Shaft

7. Gage should now be positioned. Once again, lift the gage end of the tape at a shallow angle to the surface until the gage is free of the surface. Continue pulling the tape until you are approximately 1/8" – 1/4" beyond gage. Turn the leading edge of the tape under and press it down, leaving the bonding surface of the gage exposed.
8. Apply a very thin, uniform coat of ***M-Bond 200-Catalyst*** to the bonding surface of the gage. This will accelerate the bonding when glue is applied. Very little catalyst is needed. Lift the brush cap out and wipe excess on lip of bottle. Use just enough catalyst to wet gage surface. Before proceeding, allow catalyst to dry at least one minute under normal ambient conditions of + 75°F and 30-65% relative humidity.

NOTE: The next three steps must be completed in sequence within 3 – 5 seconds. Read through instructions before proceeding so there will be no delays.

Have Ready:
M-Bond (Cyanoacrylate) Adhesive
2" – 5" piece of teflon tape
Tissues

MOUNTING THE GAGE

9. Lift the leading edge of the tape and apply a thin bead of adhesive at the gage end where the tape meets the shaft. Adhesive should be of thin consistency to allow even spreading. Extend the line of glue outside the gage installation area.
10. Holding the tape taut, slowly and firmly press with a single wiping stroke over the tape using a teflon strip (to protect your thumb from the adhesive) and a tissue (to absorb excess adhesive that squeezes out from under the tape). This will bring the gage back down over the alignment marks on the gaging area. This forces the glue line to move up and across the gage area. A very thin, uniform layer of adhesive is desired for optimum bond performance.

11. Immediately, using your thumb, apply firm pressure to the taped gage by rolling your thumb over the gage area. Hold the pressure for at least one minute. In low humidity conditions (below 30%) or if ambient temperature is below + 70° F, pressure application time may have to be extended to several minutes.
12. Leave the mylar tape on an additional five minutes to allow total drying then slowly peel the tape back directly over itself, holding it close to the shaft while peeling. This will prevent damage to the gages. It is not necessary to remove the tape immediately after installation. It offers some protection for the gaged surface and may be left until wiring the gage.

WIRING THE GAGE

13. Tin each solder pad with a solder dot. (It is helpful to polish the solder tabs, e.g. with a fiberglass scratch brush or mild abrasive, before soldering.) Trim and tin the ends of the 4-conductor ribbon wire. Solder the lead wires to the gage by placing the tinned lead onto the solder dot and pressing it down with the hot soldering iron. Note: For single-stamp torque gages, a short jumper is required between solder pads 2 and 4 as shown in the diagram on the next page
14. Use the **rosin solvent** to clean excess solder rosin from the gage after wiring. Brush the gage pads with the solvent and dab with a clean tissue.
15. Paint the gage area (including the solder pads) with **M-Coat A polyurethane** and allow to air dry 15 minutes. This protects the gage from moisture and dirt. To further protect the gage, cover with a 1.5 inch square patch of **rubber sheet** and a piece of M-Coat FA-2 **aluminum foil tape** (optional) then wrap with electrical tape.

For TORQUE Measurement

NOMINAL RESISTANCE VALUES
 +EXC TO -EXC: 350 ohms
 +SEN TO -SEN: 350 ohms
 ALL OTHER TESTS: 262.5 ohms

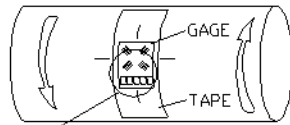

YIELDS POSITIVE OUTPUT SIGNAL FOR TORQUE DIRECTION SHOWN.
 (GAGE CAN BE ROTATED 90°. EACH ROTATION OF 90° RESULTS IN A CHANGE IN SIGN OF THE OUTPUT SIGNAL.)

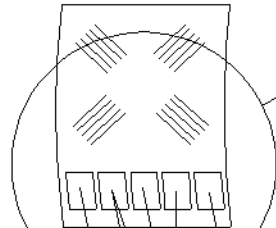

GREEN JUMPER

+EXC: RED
 -SEN: WHITE
 +SEN: GREEN
 -EXC: BLACK

STRAIN GAGE:
 VISHAY MEASUREMENTS GROUP
 RALEIGH, NC
 PHONE: 919-365-3800
 PART # CEA-06-250US-350